

HIGH CAPABILITY HORIZONTAL MACHINING CENTER

# **NHM 5000·6300·8000**

**NHM 5000**

**NHM 6300**

**NHM 8000**

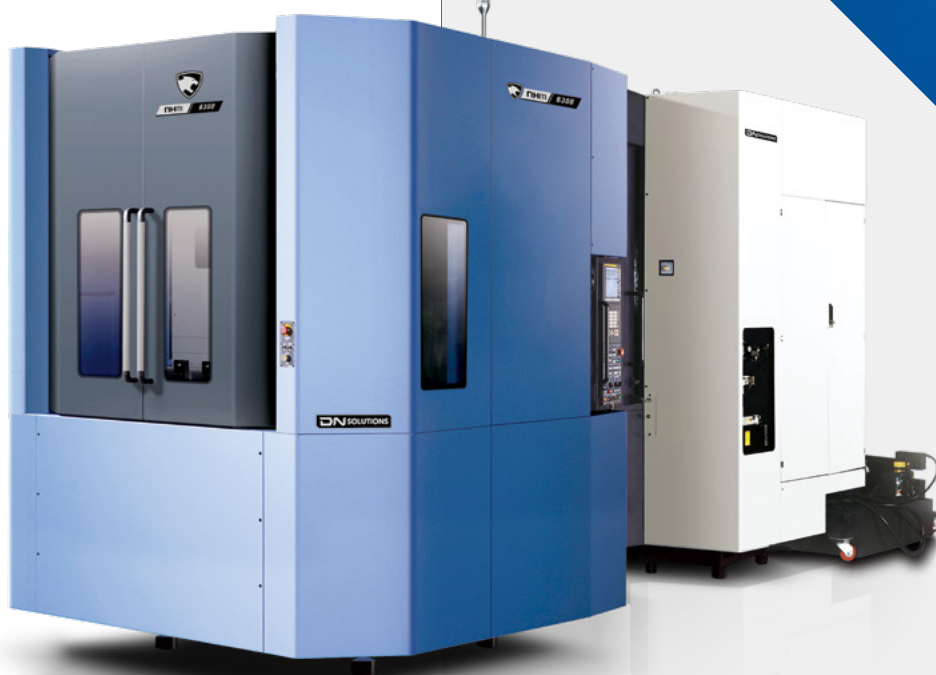

# NHM 5000 · 6300 · 8000

NHM Series provides the largest machining specifications and production capabilities in its class including powerful cutting capabilities for satisfying diversified needs for production of customers. The integrated structure of the box-type guideway is the optimal structure of excellent production capabilities for machining various materials from common parts to metal hard of cutting with its high rigidity capacity required for powerful cutting process. In addition, replacement speed of tools and palettes at servo motor driving for keeping non-cutting time minimal improves reliability and productivity.

## CONTENTS

### Product Overview

### Basic Information

- 04 Basic Structure | Travel Axis
- 05 Spindle
- 06 Automatic Pallet Changer
- 07 Magazine

### Detailed Information

- 08 Standard | Optional Specifications
- 09 Peripheral Equipment
- 10 Application
- 10 Productivity
- 11 Multi-Pallet Systems
- 13 FANUC 31iB PLUS
- 15 SIENUMERIK ONE
- 16 Convenient Operation
- 17 Power | Torque
- 18 External Dimensions
- 19 Pallet Dimensions
- 20 Tool Shank
- 21 Working Area
- 22 Machine Specifications

### Customer Support Service

- 23 Customer Support and Services
- 23 Global Network

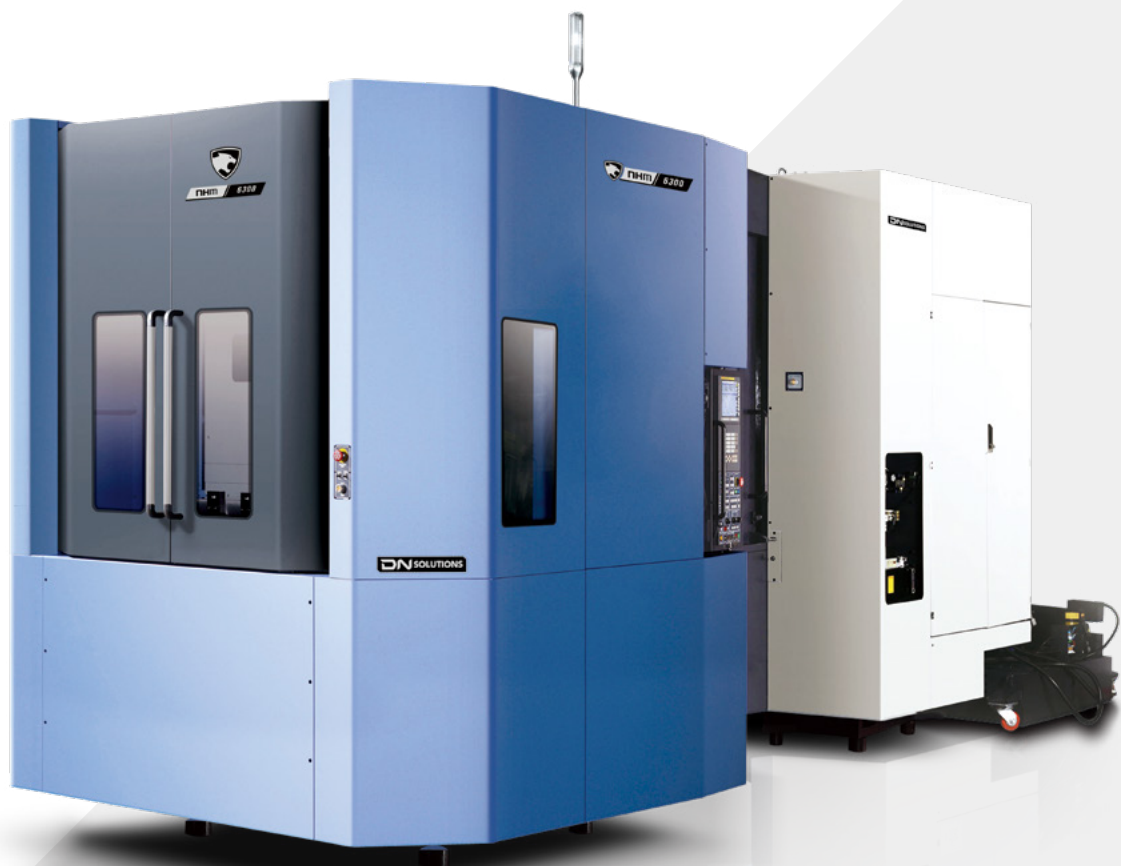

### HIGH RIGIDITY ONE-PIECE BED



- The high rigidity one-piece bed supports heavy duty cutting with the adoption of Finite Element Method (FEM) analysis.

### HIGH PRODUCTIVITY AND RELIABILITY



- The servo-driven automatic tool changer (ATC) and automatic pallet changer improve parts durability and maintainability, leading to improved product quality. Compatibility with the pallet extension system and minimized idle time ensure even higher productivity.

### USER-FRIENDLY FUNCTIONS



- Various new user-friendly functions have been introduced to reduce the operator's work load.

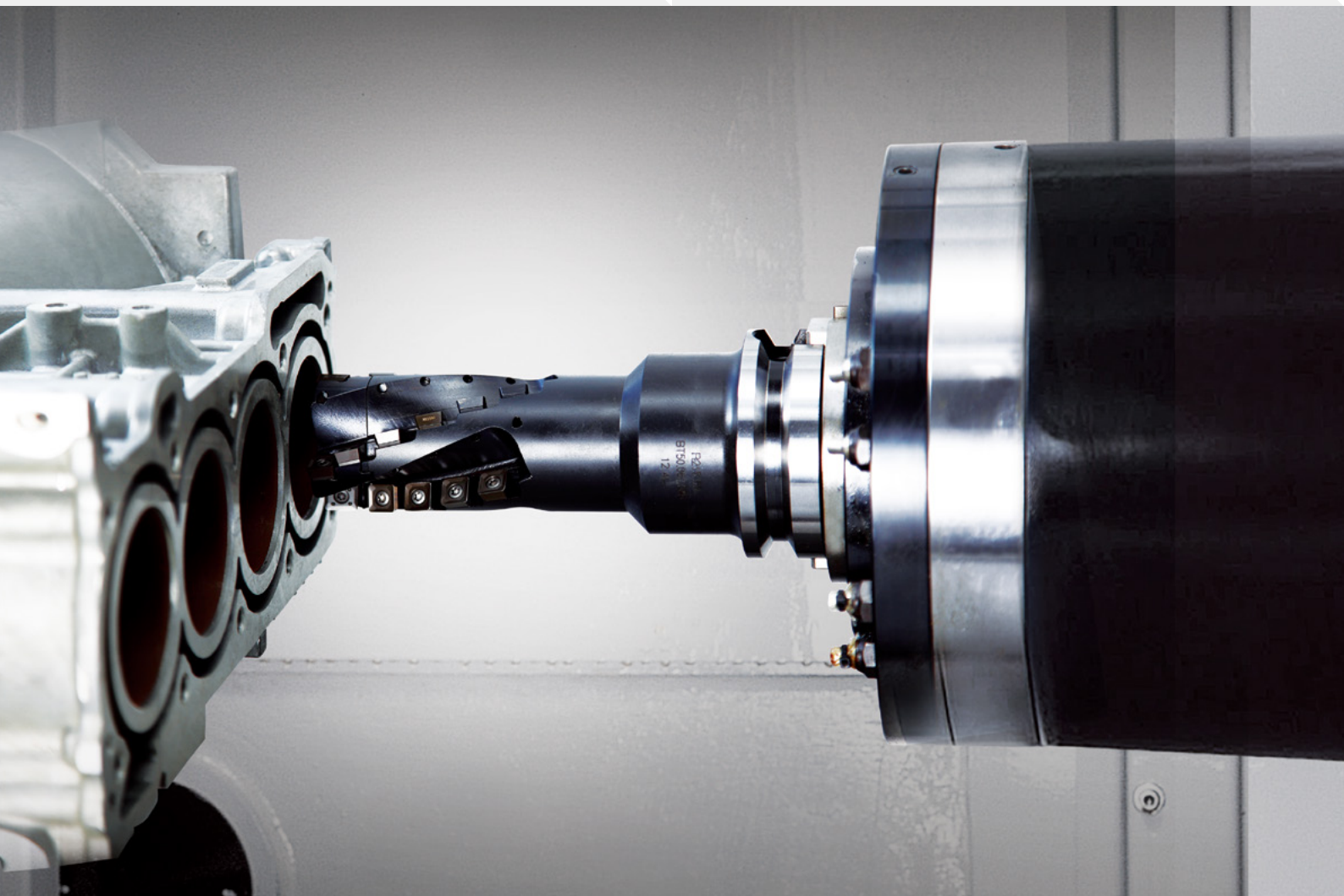

# BASIC STRUCTURE | TRAVEL AXIS

The machine of one-piece structure of the bed and the column yields high productivity.

## Double-wall configuration

The main body of the system is designed in double wall structure for preventing leak of cutting oil: This design allows easy maintenance and improves productivity as well.

## High rigidity bed structure

NHM Series is designed for keeping high stability and durability intact through FEM technologies; the series ensures continuous powerful cutting power with the structure applied with M- and W-type ribs.



W-type rib

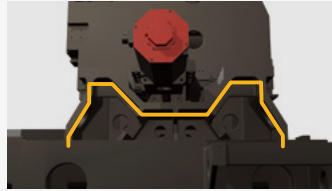

M-type rib

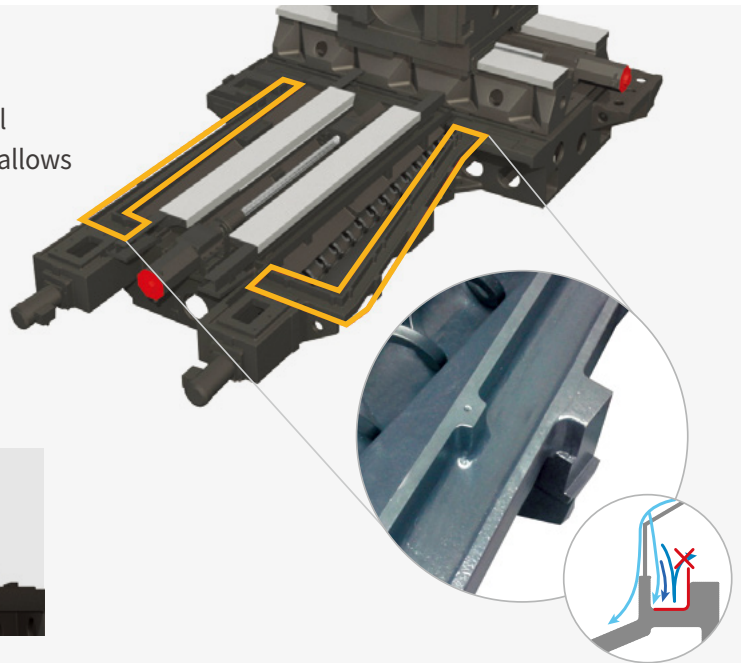

## Strong feed axis structure

The extended box-type guideways are applied to all of the axes for providing higher rigidity, and the optimal dynamic rigidity of the main sliding parts further improve capabilities of strong cutting.

Area of guideway

28% ↑

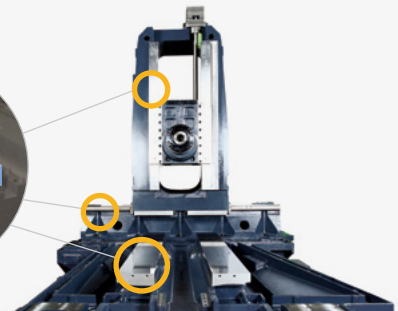
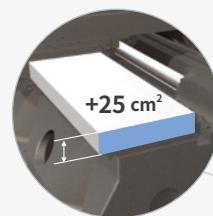

## Half-floating air structure of feed system

The half-floating air structure mitigates friction resistance during feed along the X axis resulted from the mass of the spindle and the column for improving accuracy of positioning and repeatability.

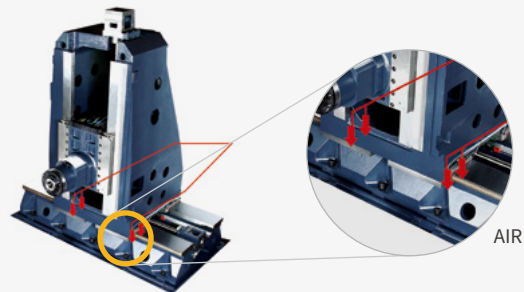

## Powerful ball screw and thermal displacement control

The 3-row bearing applied with the rigid coupling keeps precision and rigidity for individual axes high, and high accuracy is implemented by controlling thermal displacement by the ball screw locking devices and the nut cooling system on the all of the axes.

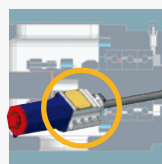

Ball Screw

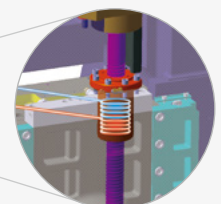
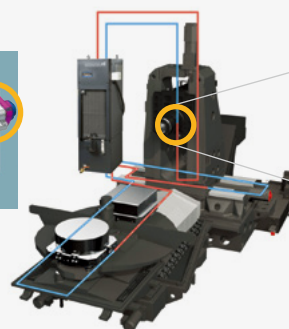
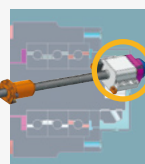

Nut Cooling

# SPINDLE

The high power gear-driven spindle of NHM Series yields excellent rigidity for diverse materials.

## Max. spindle speed

NHM 5000 / NHM 6300 / NHM 8000

**6000** r/min

## Max. spindle motor power

NHM 5000

**15 / 25** kW (20.1 / 33.5 Hp)

NHM 6300 / NHM 8000

**22 / 35** kW (29.5 / 46.9 Hp)

## Max. spindle motor torque

NHM 5000

**1034** N·m (25.8 ft-lb)

NHM 6300 / NHM 8000

**1732** N·m (1277.5 ft-lb)



## Powerful spindle

Designed to minimize vibration and thermal error while offering rapid acceleration and deceleration, the spindle guarantees excellent cutting performance from steel to nonferrous metal parts

## Spindle cooling system

The spindle temperature is kept uniform by the cooling system. The temperature sensor controls temperature of the jacket surrounding the spindle as well as the temperature of oil circulating about the spindle bearing, the gear and the motor flange for ensuring stable and precise machining.

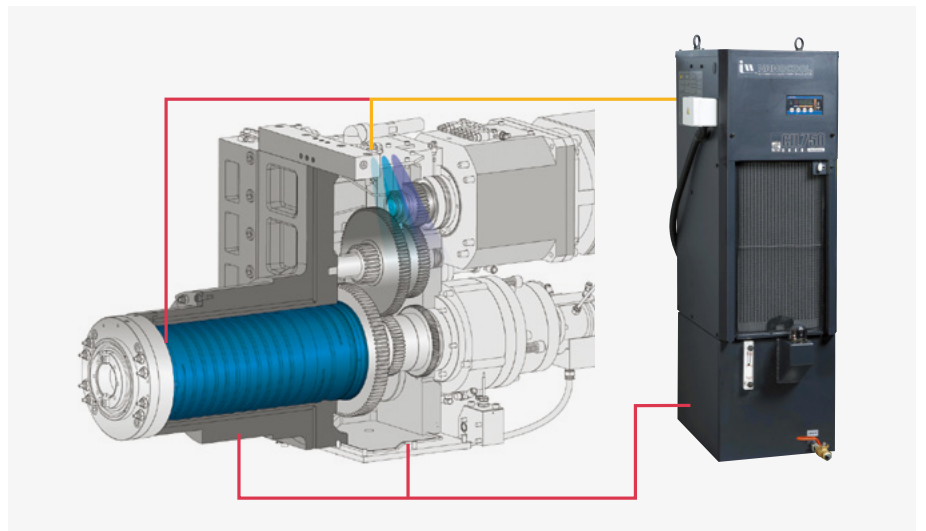

## Dual contact tool system

Tool rigidity is enhanced by the firm clamping of the spindle. Tool lifecycle and cut-surface roughness have been improved as a result of the reduced vibration realized by the dual contact spindle.

## Tool type

**ISO #50**



# AUTOMATIC PALLET CHANGER (APC)

The servo-driven APC boasts high reliability with its stable, accurate performance and reduced rejection ratio.

## Improved pallet and APC system

The servo-driven APC system realizes increased productivity with fast and accurate pallet change. In addition to its excellent reliability, the improved APC has more space for the operator's convenience.

### Pallet change time

NHM 5000

**8.5 S**

NHM 6300

**12 S**

NHM 8000

**16 S**

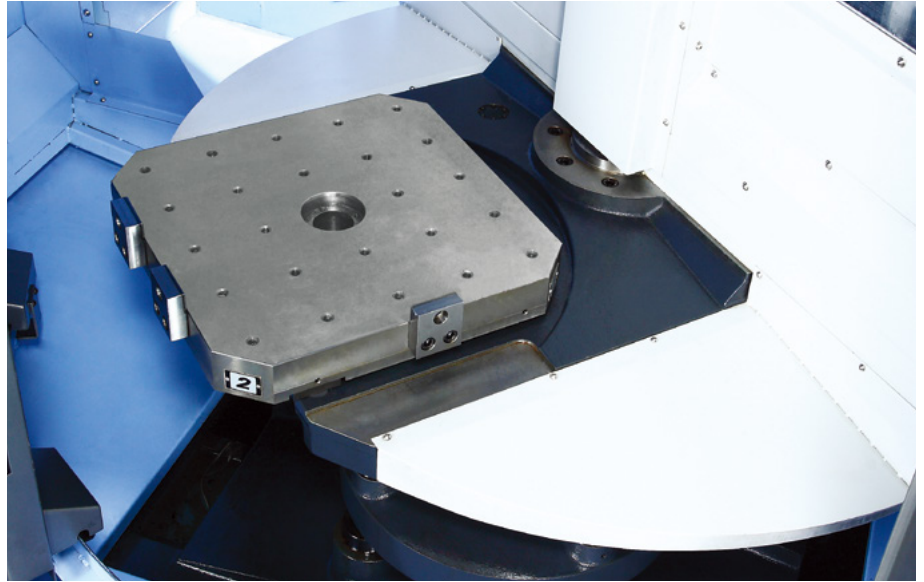

## Cone air blower

As a mechanism designed for precise pallet position repeatability, the cone air blower injects high-pressure air into the table fixing pin connecting the table and the pallet in order to remove chips from the pin and guaranteeing them seating at the correct positioning of the workpiece.

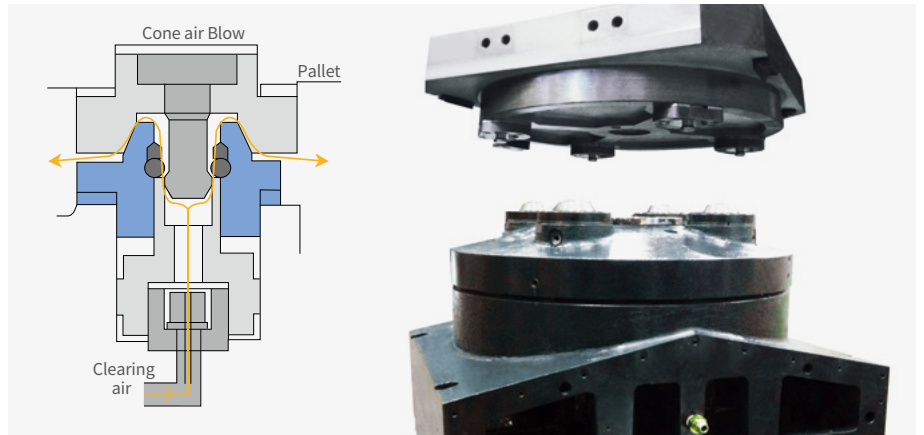

## Max. Workpiece Size

The NHM Series provides more space for heavier and larger workpieces.

Max. workpiece size (D X H)		
NHM 5000	mm (inch)	Ø 850 x 1100 (33.5 x 43.3)
NHM 6300	mm (inch)	Ø 1050 x 1350 (41.3 x 53.1)
NHM 8000	mm (inch)	Ø 1450 x 1550 (57.1 x 61.0)
Max. workpiece weight (W)		
NHM 5000	kg (lb)	800 (1763.7)
NHM 6300	kg (lb)	1200 (2645.5)
NHM 8000	kg (lb)	2000 (4409.2)

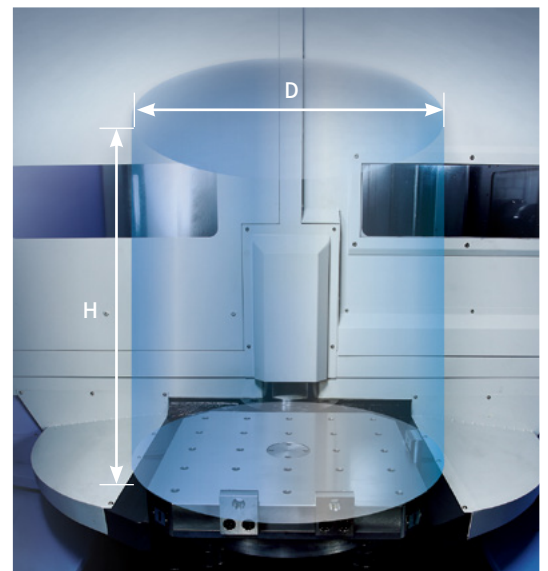

# MAGAZINE

The servo-driven ATC provides high reliability and reduces tool change time.

## Servo-driven ATC

The ATC is capable of handling weight from 25kg to 30kg at high speed using a servo motor, and fast tool indexing and spindle positioning.

Max. tool diameter x max. tool length			
Model	Unit	BT/CT/DIN	HSK
NHM 5000	mm (inch)	320 x 530 (12.6 x 20.8)	320 x 600 (12.6 x 23.6)
NHM 6300	mm (inch)	320 x 630 (12.6 x 24.8)	320 x 700 (12.6 x 27.6)
NHM 8000	mm (inch)	320 x 630 (12.6 x 24.8)	320 x 700 (12.6 x 27.6)
Tool change time (tool weight of less than 12 kg (26.5 lb))			
Model	Unit	Tool to tool	Chip to chip
NHM 5000	s	2 s	6.4 s
NHM 6300	s		6.7 s
NHM 8000	s		8 s

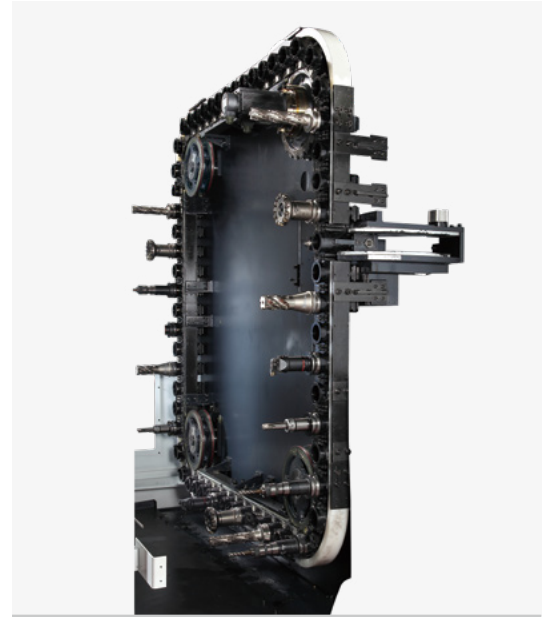

## Convenient short tool cutting

The distance between the spindle and the center of the pallet has been reduced for heavier-duty cutting with shorter tools.

### Features

- Increased tool rigidity with a larger diameter
- Innovative improvement of ATC repeatability
- Minimal Z axis displacement at high speed
- Increased tool service life

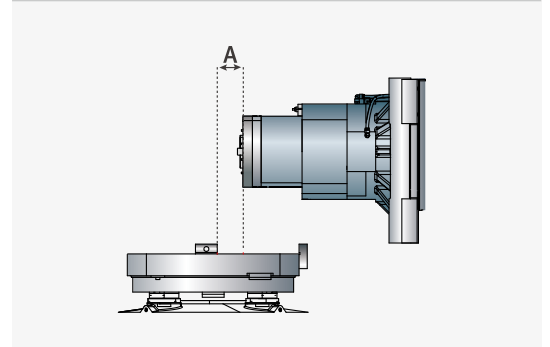

## Tool magazine for diverse types of tools, including chain and matrix tool types

The NHM Series provides 60 tools as a standard feature, and up to 376 tools as an option.

### Chain type magazine

60 ea

90 ea OPTION

120 ea OPTION

150 ea OPTION

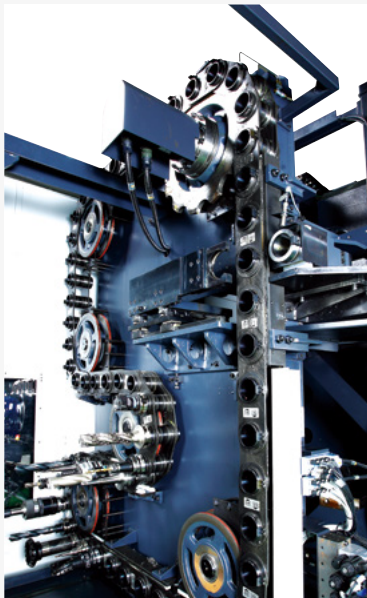

### Matrix type magazine OPTION

196 ea

256 ea

316 ea

376 ea

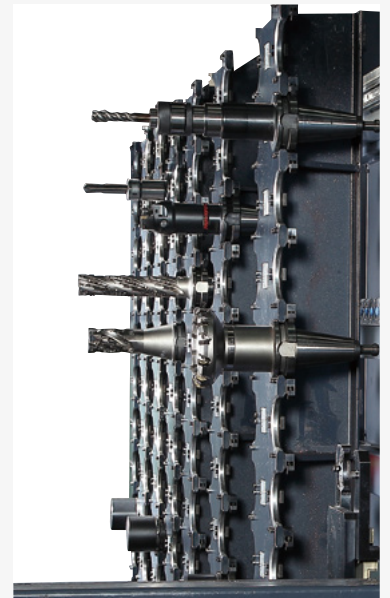

# STANDARD | OPTIONAL SPECIFICATIONS

A range of options is available to suit individual requirements.

Description	Features	NHM 5000	NHM 6300	NHM 8000	
<b>Tool magazine (No. of tool stations)</b>	60 ea	●	●	●	
	90 ea	○	○	○	
	120 ea	○	○	○	
	150 ea	○	○	○	
<b>Type of tool shank</b>	BT50	●	●	●	
	CAT50	○	○	○	
	DIN50	○	○	○	
	HSK A-100	○	○	○	
<b>Mist collector</b>	Mist collector	○	○	○	
<b>Spindle</b>	6000 r/min	15 / 25 kW (20.1 / 33.5 Hp)			
		22 / 35 kW (29.5 / 46.9 Hp)		●	
	8000 r/min	30 / 37 kW (40.2 / 49.6 Hp)	○	○	
<b>Hydraulic fixtures</b>	Hydraulic fixture line	2X2	○	○	
		4X4	○	○	
		6X6	○	○	
		8X8	○	○	
	Hydraulic fixture unit	○	○		
<b>Automatic workpiece measurement device</b>	OMP60_RENISHAW	○	○	○	
	RMP60_RENISHAW	○	○	○	
<b>Auto tool measuring device</b>	BK MIKRO	○	○	○	
	NEEDLE SWING TYPE	○	○	○	
	OMRON (Limit Switch Type)	○	○	○	
	TS27R	○	○	○	
	NC 4	○	○	○	
<b>Accuracy</b>	Linear scale (X-axis)	○	○	○	
	Linear scale (Y-axis)	○	○	○	
	Linear scale (Z-axis)	○	○	○	
<b>Chip Handling System</b>	Chip conveyor	HINGED Type	○	○	
		SCRAPER Type	○	○	
		DRUM Type	○	○	
	Chip bucket	○	○	○	
<b>Coolant</b>	FLOOD	●	●	●	
	FLUSHING	●	●	●	
	SHOWER	○	○	○	
	TSC	1.5 kW 2.0 MPA (2 Hp 290 psi)	○	○	○
		3.0 kW 3.0 MPA (4 Hp 435.1 psi)	○	○	○
		7.5 kW 7.0 MPA (10 Hp 1015.3 psi)	○	○	○
	Water soluble Coolant Chiller***	○	○	○	
	Coolant gun	○	○	○	
	Oil skimmer	●	●	●	
	MQL System	○	○	○	
Coolant level switch : Sensing level - Low / High*	○	○	○		
<b>Table</b>	Index table (1° control)	●	●	●	
	Rotary table (0.001° control)	○	○	○	
<b>Pallet</b>	Tap pallet	●	●	●	
	T-Slot pallet	○	○	○	
<b>AIR</b>	Pallet air seat	○	○	○	
	AIR GUN	○	○	○	
<b>MPG</b>	Portable MPG	●	●	●	

\* Special Quotation. \*\* When using a semi-synthetic type or synthetic type, contact our sales representative or service center in advance.

● Standard ○ Optional X/N/A

\*\*\* Technical consultation is mandatory for the chilling of non-water soluble coolant >

\* Please contact DN Solutions for detailed specification information.



There is a high risk of fire when using non-water-soluble cutting fluids, processing flammable materials, neglecting the controlled and careful use of coolants and modifying the machine without the consent of the manufacturer. Always check the SAFETY GUIDELINES carefully before using the machine.

# PERIPHERAL EQUIPMENT

## Chip conveyor **OPTION**



## Measurement systems

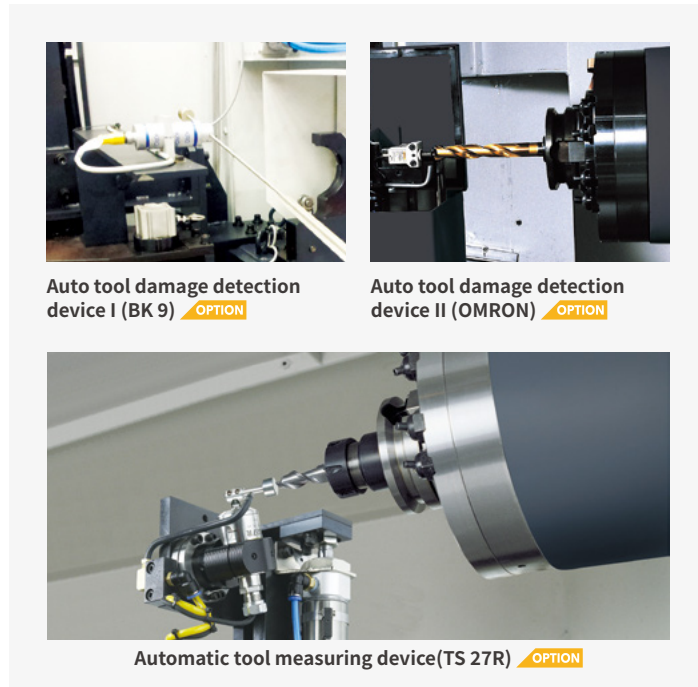

## Environmentally-friendly equipment

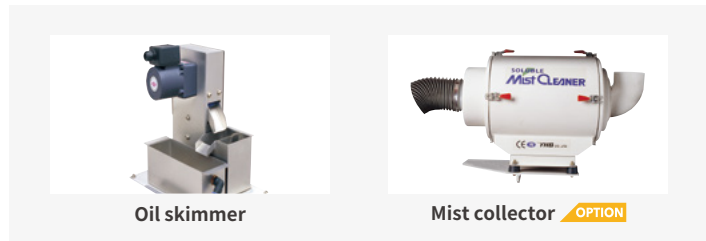

## Cutting oil cooling system **OPTION**

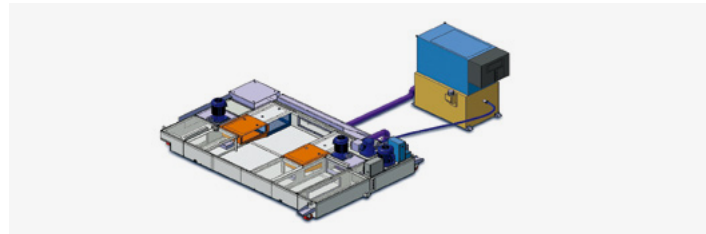

## Linear scale feedback system **OPTION**



## Chip disposal system



# APPLICATION

We offer a wide range of solutions that can be optimized to suit our customer's needs.

## Clamping fixtures

The following hydraulic and pneumatic fixture options are available for workpiece set up.

### A variety of preparations for workpiece clamping fixtures (hydraulic/pneumatic) OPTION

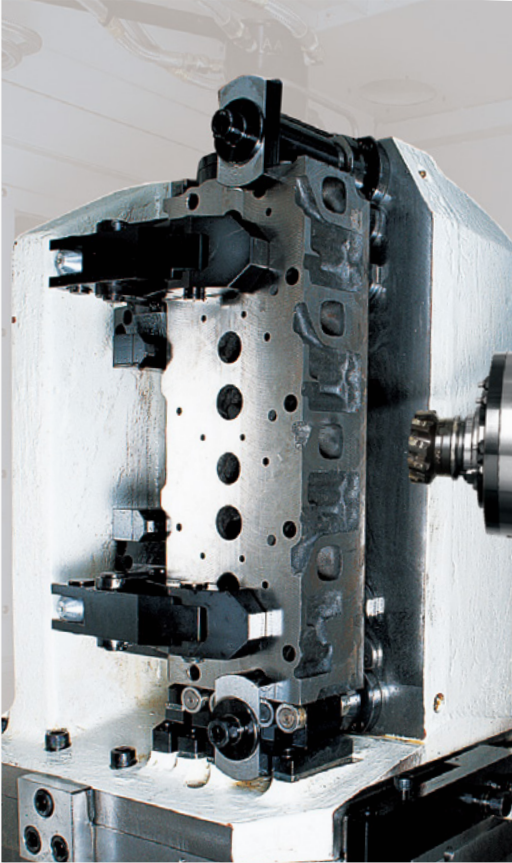

#### Hydraulic/pneumatic fixture pot

- A/B Line : 2, 4, 6, 8 Pairs (Including solenoid valve)
- P/T Line : 2, 4, 6, 8 Pairs (Excluding solenoid valve)

#### Clamping fixture hydraulic motor

- 2.2 kW(3.0 HP) / 7MPa
- 3.7 kW(5.0 HP) / 15MPa
- 5.5 kW(7.4 HP) / 21MPa
- 3.7 kW / 15MPa
- 5.5 kW / 21MPa

※ Please provide us with detailed specifications on the order sheet.

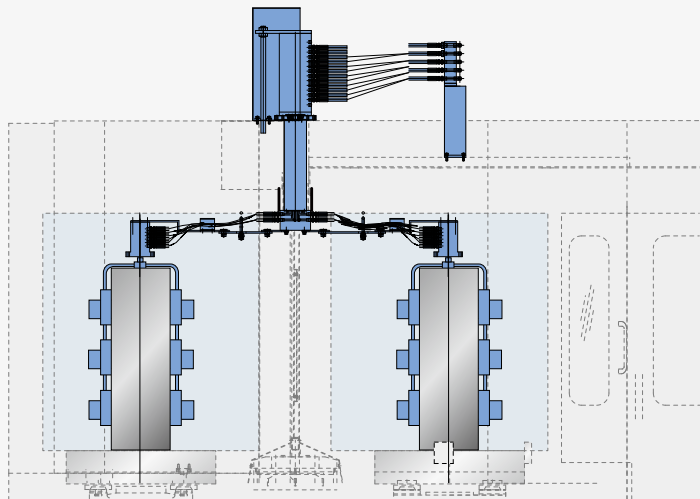

# PRODUCTIVITY

## High Productivity

**10 %** Down

- Component of automobile : Carrier middle
- Material : Cast iron
- No. of tools : 21

## Cycle time

Previous Model 2333 s

**NHP series 2110 s** ↩ **223 s**



# MULTI-PALLET SYSTEMS

DN Solutions's linear pallet system (LPS) and DN Round Storage (DRS) provides users with maximized productivity, rapid installation and commissioning, and easy maintainability.

## Linear pallet system [LPS II] OPTION

Designed to provide users with an optimised system, the LPS II linear pallet systems designed and constructed by DN Solutions, offering outstanding flexibility, including system extension and layout change.

### Features

- Easy for system extension
- Sufficient workpiece space for high level of work efficiency
- Stable and efficient system operation
- Faster installation and commissioning
- Applicable to all HMC Series machines
- Excellent maintainability

### LPS standard control software

- Easily-storable basic information for flexible production.
- Platform management software for rapid production and changes in quantity.
- LPS management solution for fast and flexible production and sudden changes in quantity.

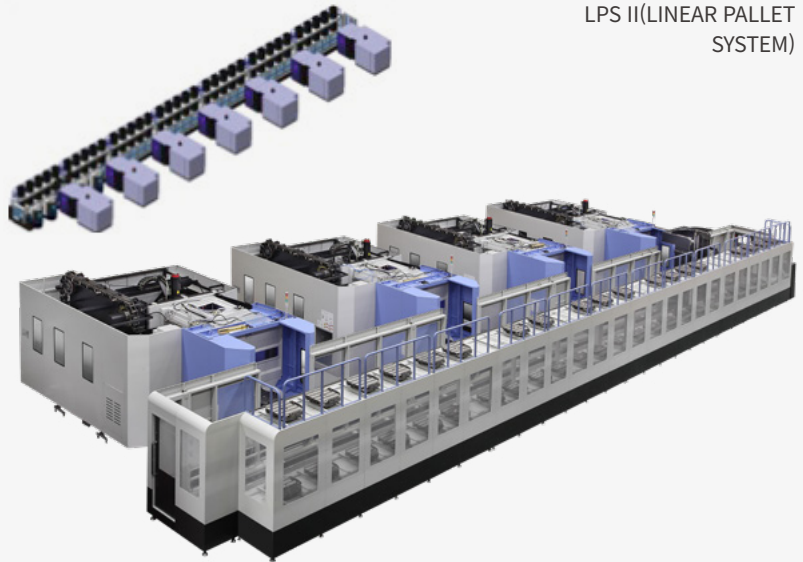

LPS II(LINEAR PALLET SYSTEM)

### Production management system [DPMS]

The DPMS is an operating system designed to ensure effective control and management of the LPS. The main window provides a solution that enables a flexible and rapid response to changes in output.

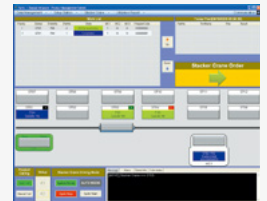

### System outline

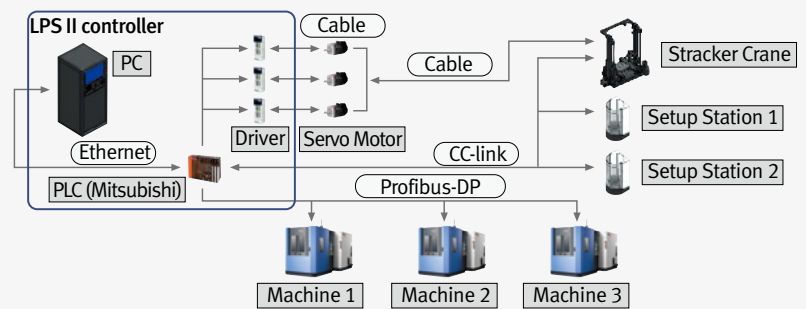

### System Options

LPS II Model	LPS 500 II	LPS 630 II	LPS 800 II
Available Model	NHM 5000	NHM 6300	NHM 8000
Forking type	Twin Fork type		
No. of machines	1 - 7		
No. of setup stations	1 - 4		
No. of pallets	12 ~ 70	10 ~ 70	8 ~ 70
Dimensions (L x W)	7824 x 2400 mm (308.0 X 94.5 inch)	7904 x 785 mm (311.2 X 30.9 inch)	8952 x 3500 mm (352.4 X 137.8 inch)

# MULTI-PALLET SYSTEMS

## DN Round Storage [DRS] OPTION

Compared with standard machines that use 2-pallet type APCs, the DRS can automatically handle 7 to 9 pallets for an extended period. This function enables small quantity batch production using machining scheduling.

The DPMS is an operating system for effective control and management of the DRS. The functions of the DPMS include scheduled operation, data input, and setting change.

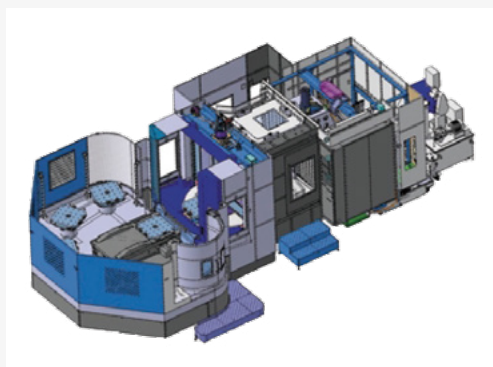
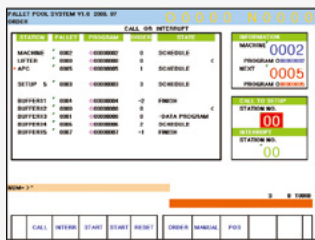

DN Round Storage



7 DRS

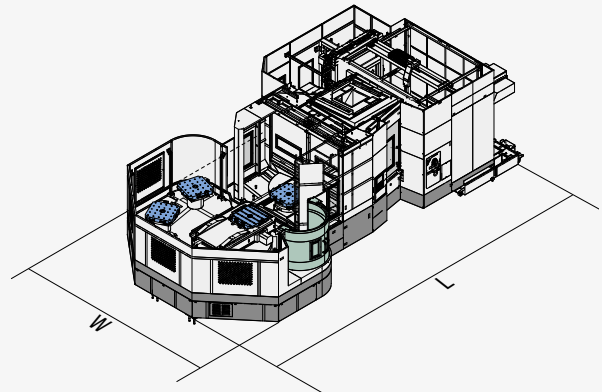

9 DRS

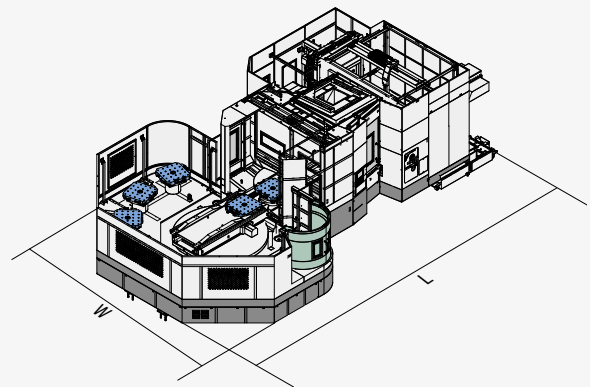

### System Options

	Unit	NHM 5000		NHM 6300		NHM 8000	
		7- DRS	9 - DRS	7- DRS	9 - DRS	7- DRS	9 - DRS
<b>No. of pallets</b>	pcs.	7	9	7	9	7	9
<b>Foot print (Length)</b>	mm (inch)	9490 (373.6)	10140 (399.2)	10560 (415.7)	11000 (433.1)	16010 (630.3)	17150 (675.2)
<b>Foot print (Width)</b>	mm (inch)	4220 (166.1)	4430 (174.4)	4780(188.2)	5770 (227.2)	5920 (233.1)	6600 (259.8)

\* Chip conveyor and DRS foot board are excluded.

# FANUC 31i PLUS

Fanuc 31i Plus maximizes customer productivity and convenience.

## 15 인치 터치화면 + New OP

DN Solutions Fanuc 31iB/B5 Plus' operation panel enhances operating convenience by incorporating common-design buttons and layout. It features a Qwerty keyboard for fast and easy data input and operation.

## FANUC 31i Plus

- 15-inch color display
- Intuitive and user-friendly design

## USB & PCMCIA card QWERTY keyboard

- EZ-Guide i standard
- Ergonomic operator panel
- 4MB Memory
- Hot keys
- Enhance AICC BLOCK
- Touch pen provided as standard

## iHMI touchscreen

iHMI provides an intuitive interface that uses a touchscreen for quick and easy operation.

## Range of applications

Providing various applications related to planning, machining, improvement and utility, for customer convenience.



## NUMERIC CONTROL SPECIFICATIONS



Item		Specifications	F31i PLUS NHM
Controlled axis	Controlled axes		4 (X,Y,Z,B)
	Simultaneously controlled axes		4 axes
	Additional controlled Axis	Add 1 Axis (5th Axis)	○
Data input/output	Fast data server		○
	Memory card input/output		●
	USB memory input/output		●
	Large capacity memory(2GB)*2	Note *2) Available Option only with 15" Touch LCD (iHMI Only)	○
Interface function	Embedded Ethernet		●
	Fast Ethernet		○
	Enhanced Embedded Ethernet function		●
Operation	DNC operation	Included in RS232C interface.	●
	DNC operation with memory card		●
Program input	Workpiece coordinate system	G52 - G59	●
	Addition of workpiece coordinate system	G54.1 P1 X 48 (48 pairs)	●
	Tool number command		T4 digits
	Tilted working plane indexing command	G68.2 TWP	○
Feed function	AI contour control II	G5.1 Q_, 600 Blocks	○
	AI contour control II	G5.1 Q_, 1000 Blocks	●
	High smooth TCP		X
Operation Guidance Function	EZ Guidei (Conversational Programming Solution)		○
	iHMI with Machining Cycle	Note *1) Only with 15" Touch LCD standard	●
	EZ Operation package		●
Setting and display	CNC screen dual display function		●
Network	FANUC MT Connect		⊕
	FANUC OPC UA		⊕
Others	Display unit	15" color LCD	X
		15" color LCD with Touch Panel	●
		640M(256KB)_500 programs	X
		1280M(512KB)_1000 programs	X
		2560M(1MB)_1000 programs	X
		5120M(2MB)_1000 programs	X
		10240M(4MB)_1000 programs	●
		20480M(8MB)_1000 programs	○
		2560M(1MB)_2000 programs	○
		5120M(2MB)_4000 programs	○
		10240M(4MB)_4000 programs	○
20480M(8MB)_4000 programs	○		

Network: FANUC MTConnect and FANUC OPC UA available.

\* The number of look-ahead blocks may be changed or limited depending on the peripheral device or the configuration of the internal NC system.

# EZ WORK

The software developed by DN Solutions features numerous functions designed for convenience and ease of operation.

## EZ WORK

The EZ work package delivers speed and efficiency. This menu-driven innovation not only helps customers reduce setup times, but also simplifies common tasks and procedures, reducing the potential for errors. EZ work reduces operating time, protects machinery, enhances quality and speeds up maintenance interventions.

## Tool support functions

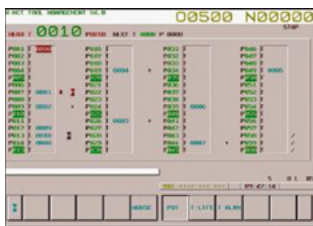

### Tool management I

- Tool magazine control
- Tool state display
- Fastems Tool Add/Remove Function **OPTION**



### Tool management II **OPTION**

- Tool magazine control
- Tool life management
- Tool life prediction
- Balluff Tool ID function
- Tool state control



### Tool load monitor **OPTION**

- Detection of tool damage
- Detection of abnormalities during operation
- Detection of no-load air cutting

## Productivity improvement functions

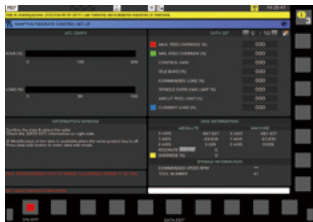

### Adaptive Feed Control

Function to control feedrate so that the cutting can be carried out at a constant load



### APC Setting Screen

A simple automation function that supports automatic processing of the next pallet by setting the processing program for each pallet of the equipment including APC in advance

## Pallet magazine support functions



### PMC Soft Panel Switch

Manual operations that occur continuously in each stages for APC, ATC change command

## Operation support, Help desk functions

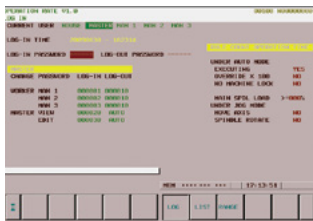

### Operation rate

- Measure various machine operating rate
- Support 3 shift operation
- calculate and save 30 days operating rate
- Show data for a specific period

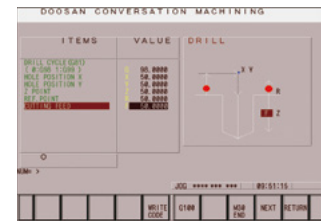

### Pattern Cycle

A function to automatically create frequently used part programs.

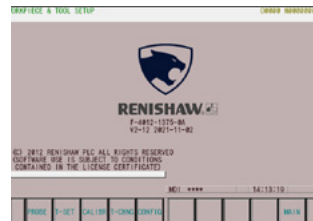

### Renishaw GUI

Renishaw tool length measuring and compensate function



### Spindle Warm Up

A function that assists spindle warm-up for spindle life when the spindle has not been used for a certain period of time

# CONVENIENT OPERATION

## SIENUMERIK ONE

### Even Faster & Easier processing + 398mm screen

All programming, set-up, actual machining and verification process are getting easier and faster. Especially, intuitive conversational programming guidance with 3D UI(user interface) on 18.5" large touch screen is helpful for unskilled engineers.

- 18.5 inch touch screen
- 50% improvement in processing speed (compared to S840D)
- Graphic programming
- PLC-based flexible automation/peripheral device expandability



### Conversational convenient function

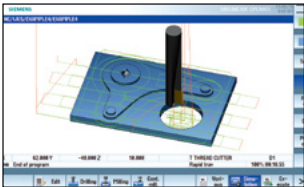

Simulation and machining contour monitoring

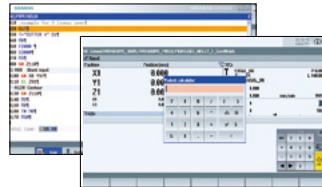

Smart function

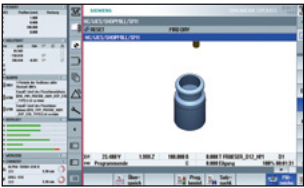

Side screen widget

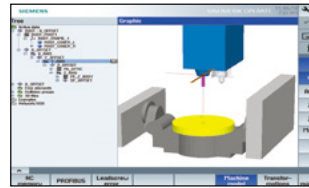

3D collision avoidance and collision avoidance ECO

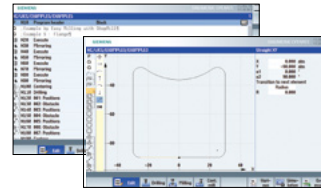

Shop mill part programming

## NUMERIC CONTROL SPECIFICATIONS



Item		Specifications	S-ONE
Controlled axis	Controlled axes		4 axes (X, Y, Z, B)
	Simultaneously controlled axes		4 axes
Data input/output	Memory card input/output	(Local drive)	●
	USB memory input/output		●
Interface function	Ethernet	(X130)	●
Operation	On network drive	(without EES option, Extcall)	●
	On USB storage medium, e.g. memory stick	(without EES option, Extcall)	●
Program input	Workpiece coordinate system	G54 - G57	●
	Addition of workpiece coordinate system	G505 - G599	●
Interpolation & Feed function	Top surface		○
	Look ahead number of block		1000
	3D simulation, finished part		●
Programming & Editing function	Simultaneous recording		●
	DXF Reader for PC integrated in SINUMERIK Operate		○
			○
Operation Guidance Function	ShopMill		●
	EZ Work		●
Setting and display	Operation via a VNC viewer		●
Network	MTConnect		⊕
	OPCUA		○
Others	18.5" color display with touch screen		●
	21.5" color display with touch screen		○
	CNC user memory	10 MB	●
	Max. CNC user memory	28 MB	○
	Collision avoidance (machine, working area)		○
	Collision avoidance ECO (machine, working area)		○

# CONVENIENT OPERATION

Ergonomic design guarantees users' convenience and safety.

## User-oriented design

Internal footings and an anti-door-lock function are provided to prevent the operator from being locked in the machine and to guarantee the operator's safety. The centralized service unit and screen panel enhance the operator's convenience.

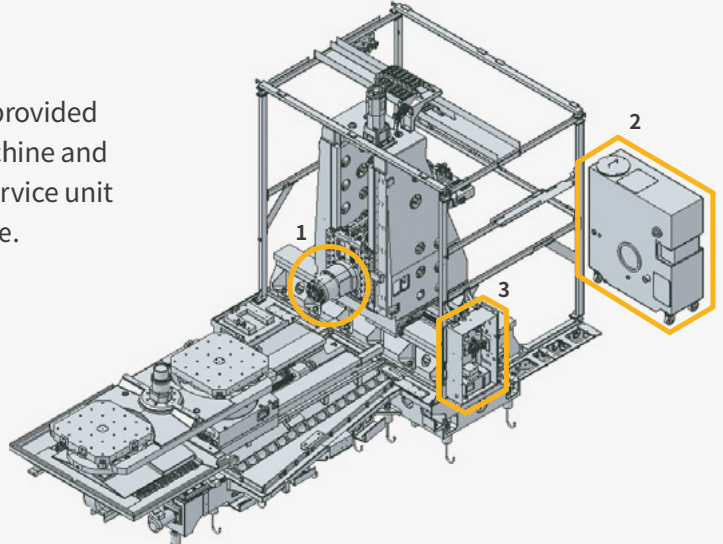

**1. Flushing system to remove chips from the spindle top and slide cover.**



**2. Coolant through spindle function for enhanced productivity** OPTION

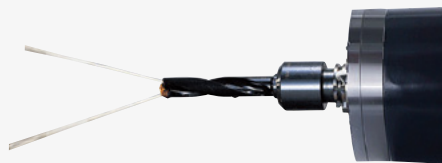

**3. Centralized utility service unit**

The utilities service unit is centralized for convenient maintainability.



**ATC screen panel provides easy tool data entry at the tool magazine area**



**Safety has been improved with machine internal footings**

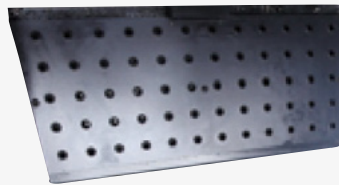

**Anti-door lock device**



## User Convenience

### Swiveling Operating Panel

The operating panel can swivel by 90°, and displays various alarm messages concerning machine and controller error, enhancing the operator's convenience.



### Portable MPG

The portable MPG allows the user to set up workpieces more easily.



### PCMCIA Card

The PCMCIA card enables uploading and downloading of the NC program, NC parameters, tool information, and ladder programs, and also supports DNC operation.

### USB Port

Upload/download of NC software programs, NC parameters, tool information and ladder program using a USB drive is allowed, but DNC operation is not supported.



# POWER | TORQUE

## NHM 5000

Spindle Speed **6000** r/min

Spindle Motor **25 / 15** kW  
(33.5/20.1 Hp)

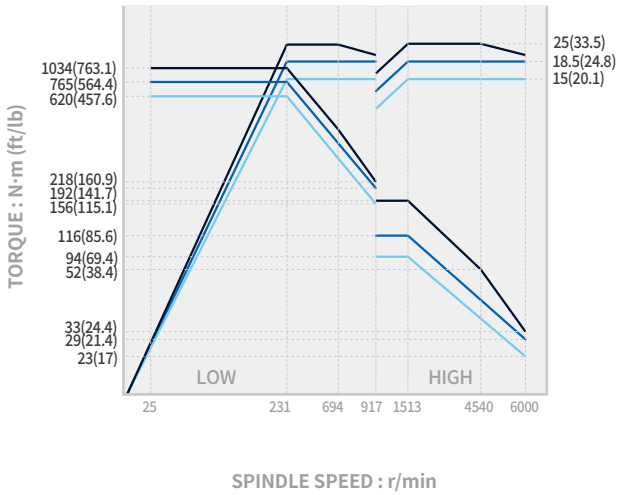

## NHM 5000 **OPTION**, NHM 6300/8000

Spindle Speed **6000** r/min

Spindle Motor **35 / 22** kW  
(46.9/29.5 Hp)

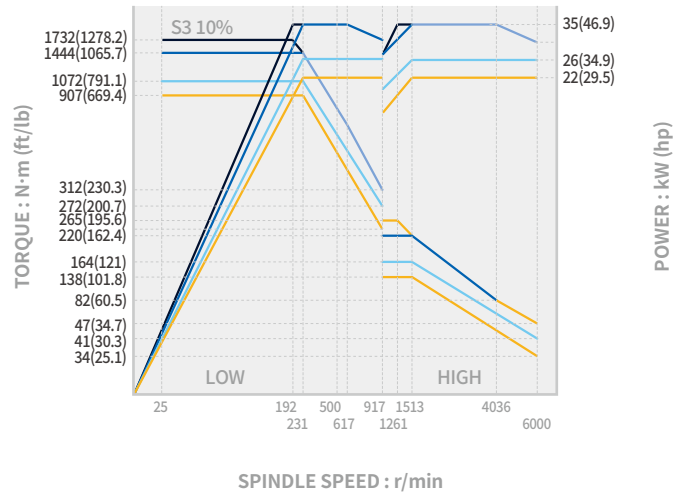

## NHM 5000/6300/8000 **OPTION**

Spindle Speed **6000** r/min

Spindle Motor **37 / 30** kW  
(49.6/40.2 Hp)

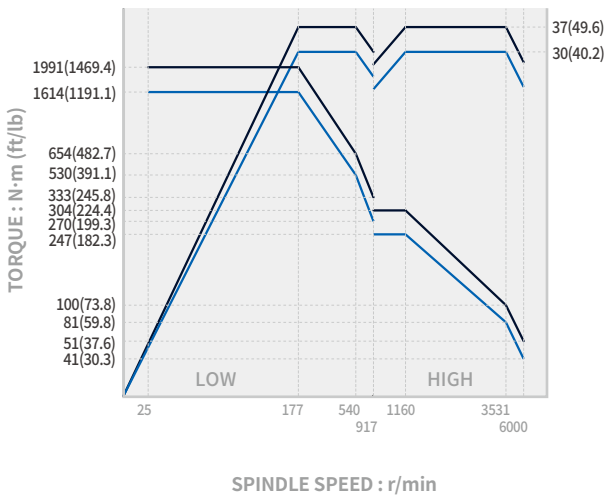

## NHM 5000/6300/8000 **OPTION**

Spindle Speed **8000** r/min

Spindle Motor **35 / 22** kW  
(46.9/29.5 Hp)

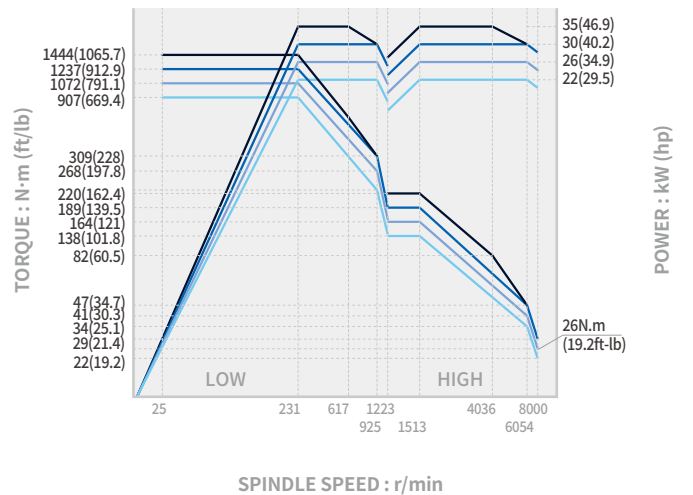

# DIMENSIONS

Units : mm (inch)

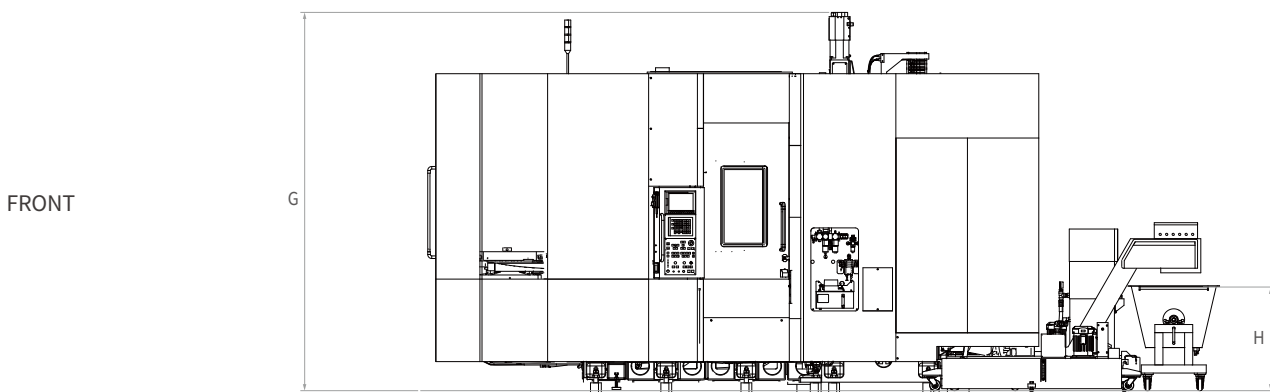
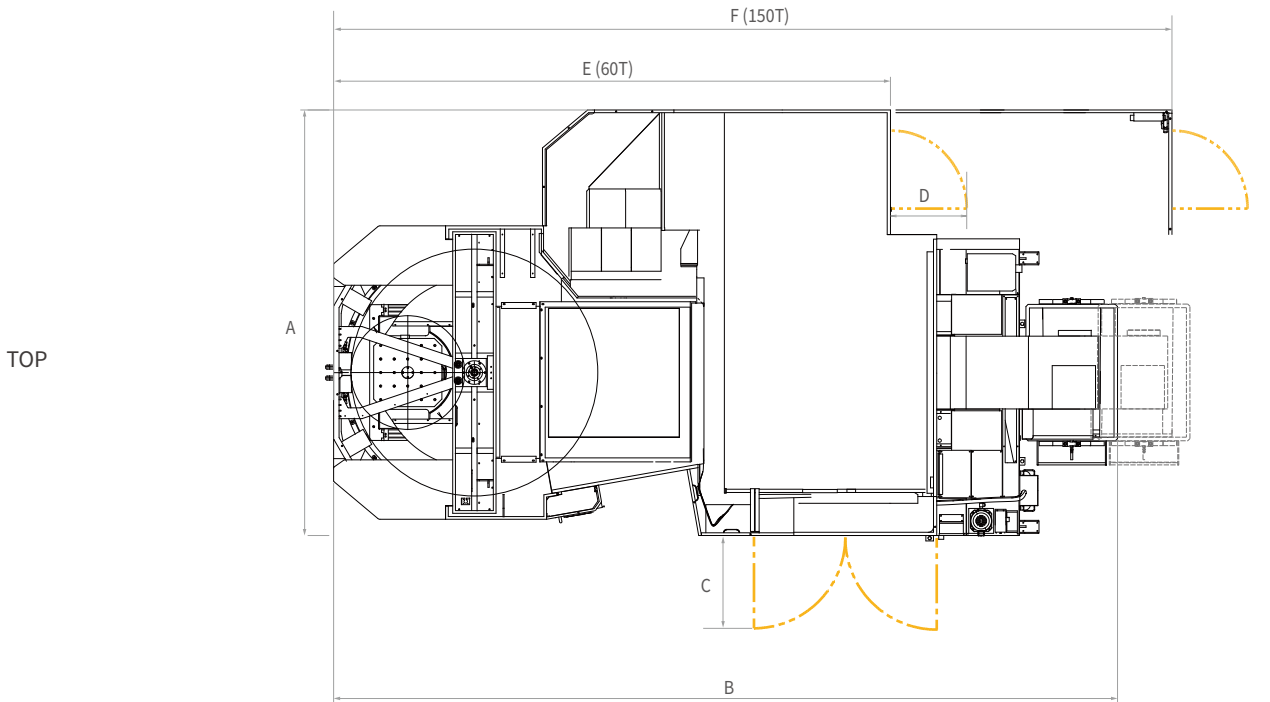

Model	A	B	C	D	E	F	G	H
NHM5000	3670 (144.5)	6830 (268.9)	660 (25.9)	745 (29.3)	4675 (184.1)	7305 (287.6)	3330 (131.1)	1085 (42.7)
NHM6300	3930 (154.7)	7300 (287.4)	660 (25.9)	745 (29.3)	5145 (202.6)	7745 (304.9)	3495 (137.6)	1085 (42.7)
NHM8000	4325 (170.3)	8265 (325.4)	660 (25.9)	745 (29.3)	6000 (236.2)	8630 (339.8)	3760 (148)	1085 (42.7)

# PALLET

## NHM 5000

Units : mm (inch)

STANDARD SPECIFICATIONS (500 × 500(19.7X19.7))

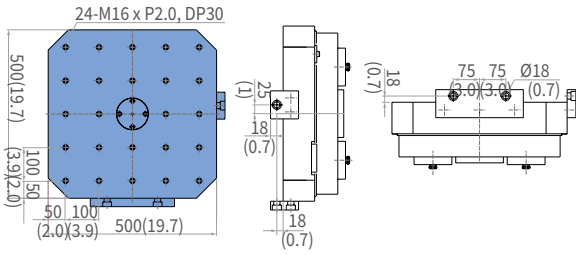

OPTIONAL SPECIFICATIONS (630 × 630(24.8X24.8))

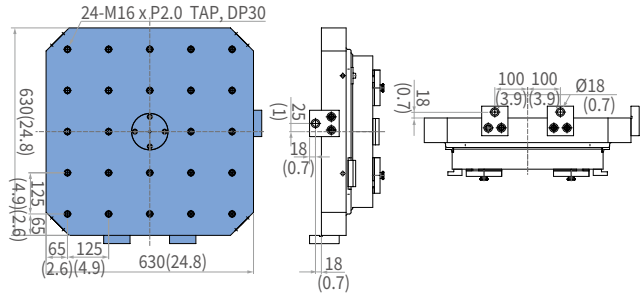

## NHM 6300

STANDARD SPECIFICATIONS (630 × 630(24.8X24.8))

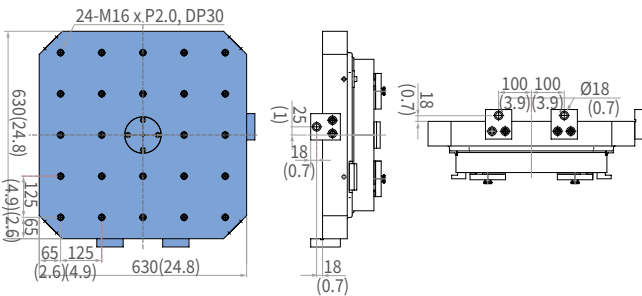

OPTIONAL SPECIFICATIONS (800 × 800(31.5X31.5))

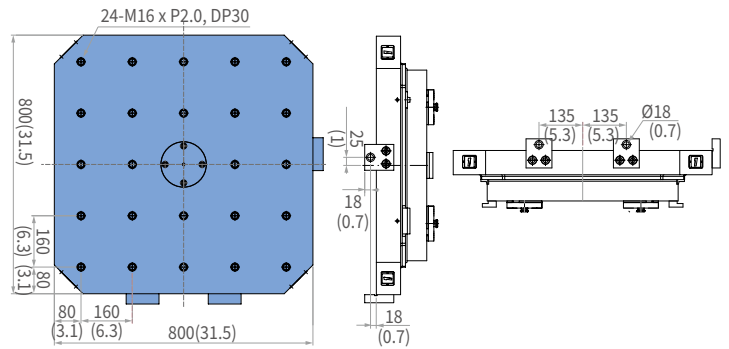

## NHM 8000

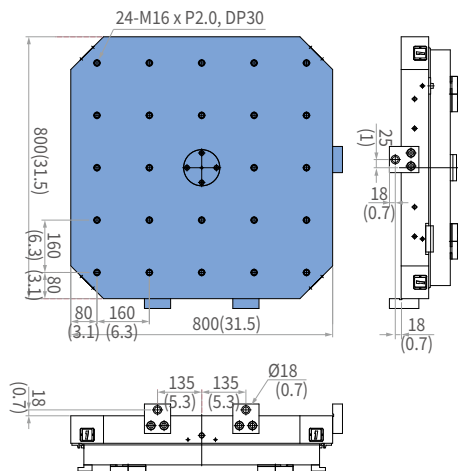

\* Some peripheral equipment can be placed in other areas.

# TOOL SHANK

## BT50

Units : mm (inch)

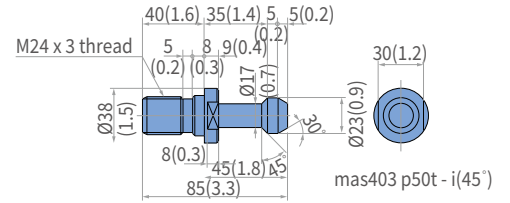
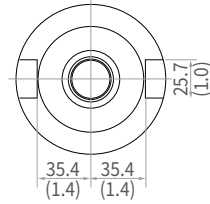
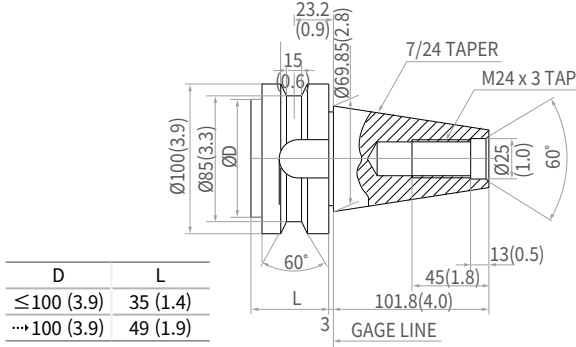

## DIN50

Units : mm (inch)

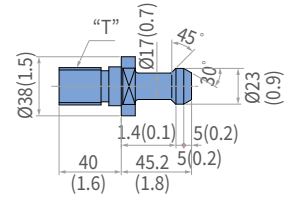
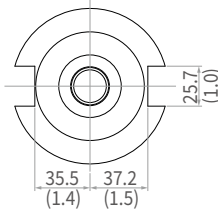
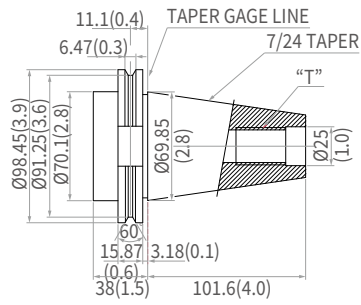

## CAT50

Units : mm (inch)

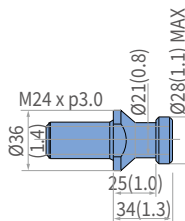
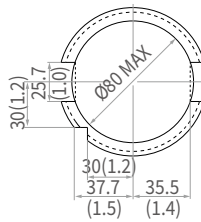
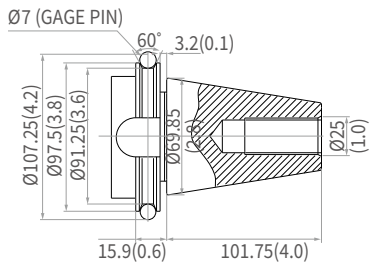

## Boring bar Size

Units : mm (inch)

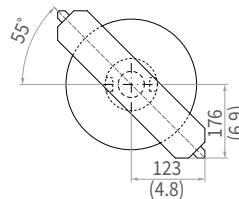
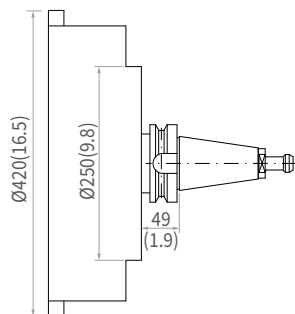

# WORKING AREA

Units : mm (inch)

Workpiece working area

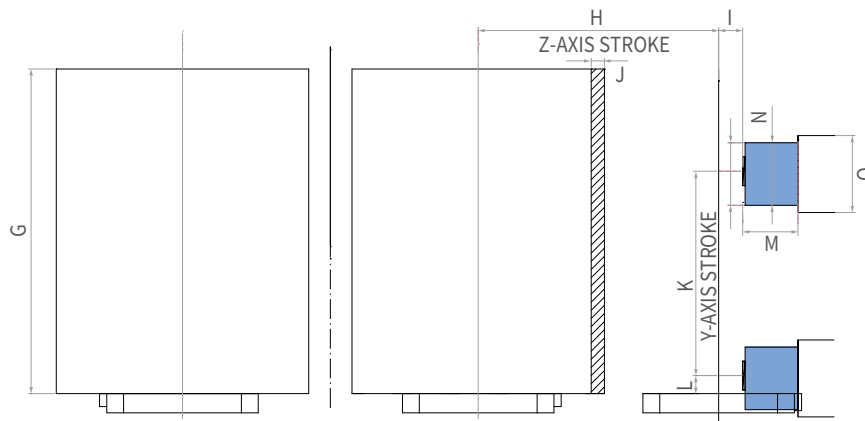
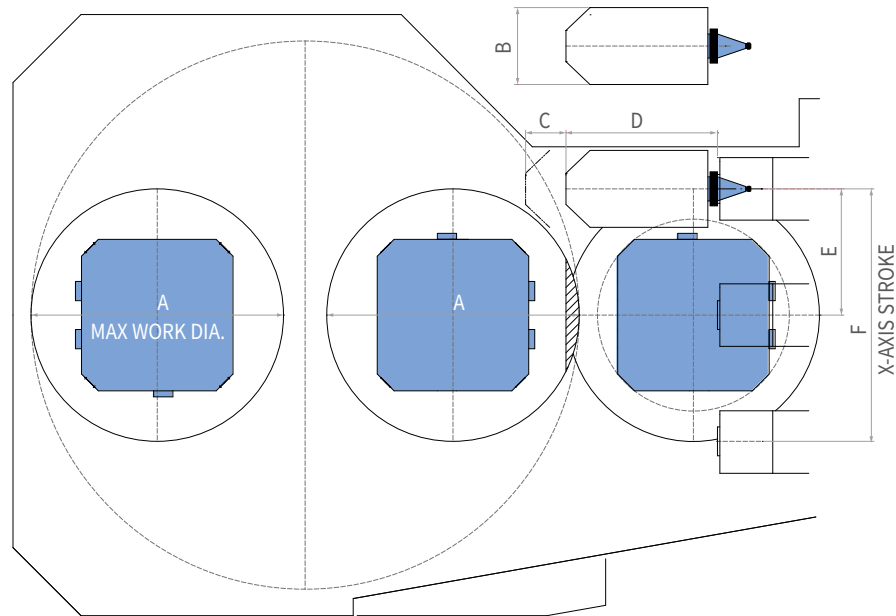

Model	A	B	C	D	E	F	G	H	I	J	K	L	M	N	O
NHM 5000	Ø850 (33.5)	Ø320 (12.6)	168 (6.6)	530 (20.9)	400 (15.7)	800 (31.5)	1100 (43.3)	850 (33.5)	100 (3.9)	5 (0.2)	750 (29.5)	75 (3.0)	230 (9.1)	Ø260 (10.2)	Ø320 (12.6)
NHM 6300	Ø1050 (41.3)	Ø320 (12.6)	168 (6.6)	630 (24.8)	525 (20.7)	1050 (41.3)	1350 (53.1)	1000 (39.4)	100 (3.9)	55 (2.2)	850 (33.5)	75 (3.0)	230 (9.1)	Ø260 (10.2)	Ø320 (12.6)
NHM 8000	Ø1450 (57.1)	Ø320 (12.6)	168 (6.6)	630 (24.8)	700 (27.6)	1400 (55.1)	1550 (61.0)	1200 (47.2)	150 (5.9)	5 (0.2)	1050 (41.3)	75 (3.0)	230 (9.1)	Ø260 (10.2)	Ø320 (12.6)

\* Some peripheral equipment can be placed in other areas.

# MACHINE SPECIFICATIONS

Description		Unit	NHM 5000	NHM 6300	NHM 8000	
Cutting Capacity	Travel distance	X-axis	mm (inch)	800 (31.5)	1050 (41.3)	1400 (55.1)
		Y-axis	mm (inch)	700 (27.6)	850 (33.5)	1050 (41.3)
		Z-axis	mm (inch)	850 (33.5)	1000 (39.4)	1200 (47.2)
	Distance from spindle nose to table center		mm (inch)	100 ~ 950 (3.9 ~ 37.4)	100 ~ 1100 (3.9 ~ 43.3)	150 ~ 1350 (5.9 ~ 53.1)
	Distance from spindle center to table top		mm (inch)	75 ~ 775 (2.9 ~ 30.5)	75 ~ 925 (2.9 ~ 36.4)	75 ~ 1125 (2.9 ~ 44.3)
Feed Rate	Rapid feed rate	X-axis	m/min (ipm)	30 (1181.1)		24 (944.9)
		Y-axis	m/min (ipm)	30 (1181.1)		24 (944.9)
		Z-axis	m/min (ipm)	30 (1181.1)		24 (944.9)
	Cutting feed rate		mm/min (ipm)	15000 (590.6)		12000 (472.4)
Pallet	Pallet type		24-M16 × P2.0			
	Pallet indexing angle		deg	1 {0.001}		
	Max. loading capacity		kg (lb)	800 (1763.7)	1200 (2645.5)	2000 (4409.2)
	Max. workpiece size		mm (inch)	Ø 850 x 1100 (Ø 33.5 / 43.3)	Ø 1050 x 1350 (Ø 41.3 / 53.1)	Ø 1450 x 1550 (Ø 57.1 / 61)
	Pallet size		mm (inch)	500 x 500 (19.7 x 19.7)	630 x 630 (24.8 x 24.8)	800 x 800 (31.5 x 31.5)
Spindle	Max spindle speed		r/min	6000 {8000}		
	Taper specifications			ISO #50, 7/24 TAPER		
	Max. torque		N·m (ft·lb)	1034 {1444} (368.8 {1065})	1732 {1444} (1277.5 {1065})	
Auto Pallet Changer (APC)	No. of pallets		ea	2		
	Pallet change time		s	8.5	12	16
	APC indexing angle (rotation)		deg	90		
Automatic Tool Changer (ATC)	Tool shank type		BT50 {CAT50 / DIN50 / HSK-A100}			
	Tool storage capacity	Chain type	ea	60 {90 / 120 / 150}		
		Matrix type	ea	{196 / 256 / 316 / 376}		
	Max. tool diameter	W/O adjacent tool	mm (inch)	320 (12.6)		
		With adjacent tool	mm (inch)	130 (5.1)		
	Max. tool length		mm (inch)	530 (20.8) (BT / CAT / DIN), 600 (HSK)	630 (24.8) (BT / CAT / DIN), 700 (HSK)	630 (24.8) (BT / CAT / DIN), 700 (HSK)
	Max. tool weight		kg (lb)	30 (66)		
	Max. tool moment		N·m (ft·lbs)	34.3 (25.3)		
	Tool change time (tool to tool, tools weighing less than 12kg(26.5lb))		s	2		
Tool change time (chip-to-chip, tools weighing less than 12kg(26.5lb))		s	6.4	6.7	8	
Motor	Spindle motor power		kW (Hp)	25 / 15 {35 / 22} (33.5 / 20.1 {46.9 / 29.5})	35 / 22 (46.9 / 29.5)	
Power Source	Power consumption		kVA	60	70	
	Compressed air pressure		Mpa (psi)	0.54 (78.3)		
Tank Capacity	Coolant tank capacity		L (gallon)	825 (217.9)	925 (244.4)	
	Lubricant tank capacity		L (gallon)	7.2 (1.9)		
Machine Dimensions	Height		mm (inch)	3330 (131.1)	3495 (137.6)	3760 (148)
	Length		mm (inch)	6075 (239.2)	6522 (256.8)	7380 (290.6)
	Width		mm (inch)	3670 (144.5)	3930 (154.7)	4325 (170.3)
	Weight		kg (lb)	18500 (40785.5)	20500 (45194.8)	25500 (56217.9)

\*{ }: Option

# RESPONDING TO CUSTOMERS **ANYTIME, ANYWHERE**

## DN SOLUTIONS GLOBAL NETWORK

**66** COUNTRIES | **140** + SALES NETWORKS | **3** FACTORIES | **6** REGIONAL HQS



## CUSTOMER SUPPORT AND SERVICES

### WE'RE THERE FOR YOU WHENEVER YOU NEED US.

We help our customers operate at maximum efficiency by providing them with a range of tried, tested and trusted services - from pre-sales consultancy to post-sales support.

	<p><b>FIELD SERVICES</b></p> <ul style="list-style-type: none"> <li>• On-site service</li> <li>• Machine installation and testing</li> <li>• Scheduled preventive maintenance</li> <li>• Machine repair service</li> </ul>		<p><b>PARTS SUPPLY</b></p> <ul style="list-style-type: none"> <li>• Supplying a wide range of original DN Solutions spare parts</li> <li>• Parts repair service</li> </ul>
	<p><b>TRAINING</b></p> <ul style="list-style-type: none"> <li>• Programming, machine setup and operation</li> <li>• Electrical and mechanical maintenance</li> <li>• Applications engineering</li> </ul>		<p><b>TECHNICAL SUPPORT</b></p> <ul style="list-style-type: none"> <li>• Supports machining methods and technology</li> <li>• Responds to technical queries</li> <li>• Provides technical consultancy</li> </ul>

**Head Office**

19F, 10, Tongil-ro, Jung-gu, Seoul,  
Republic of Korea, 04527

Tel: +82-2-6972-0370  
Fax: +82-2-6972-0400

**DN Solutions America**

360 E State PKWY,  
Schaumburg, IL. 60173,  
United states

Tel: +1-315-265-7500

**DN Solutions Europe**

Emdener Strasse 24, D-41540  
Dormagen, Germany

Tel: +49-2133-5067-100  
Fax: +49-2133-5067-111

**DN Solutions India**

No.82, Jakkuar Village  
Yelahanka Hobil,  
Bangalore-560064

Tel: +91-80-2205-6900  
E-mail: [india@dncompany.com](mailto:india@dncompany.com)

**DN Solutions China**

Room 101,201,301,  
Building 39 Xinzhuan Highway  
No.258 Songjiang District  
China Shanghai (201612)

Tel: +86 21-5445-1155  
Fax: +86 21-6405-1472

**DN Solutions Vietnam**

M.O.R.E building 2F, 40A-40B Ut  
Tich Street, 04 Ward 04,  
District Tan Binh District,  
Ho Chi Minh City, Vietnam

Tel: +84 28-7304-0163

**DN Solutions Mexico**

Avenida Parque Bicentenario  
#100 Nave M65L3-6,  
Fraccionamiento San Isidro  
Business Park,  
Santa Rosa Jauregui,  
Querétaro, México

E-mail: [efrain.figueroa@dncompany.com](mailto:efrain.figueroa@dncompany.com)

**Sales inquiry**

[sales@dncompany.com](mailto:sales@dncompany.com)